



# rotatoire

*Black & White*

*built to natural comfort*



**acorn**®  
*ceiling fan specialist*

[www.acornceilingfan.com](http://www.acornceilingfan.com)

# rotatoire

*Black & White*



AC-101 BK

Model	:	AC-101
Motor	:	153
Length	:	1220mm (48")
Blade	:	Acrylic (ABS)
Housing	:	Metal
RPM	:	140 - 230
Wind Power	:	2.8m/s
Voltage	:	220~240V/50HZ
Watt	:	60W



AC-101 WH

ceiling fan technical specification



Model	:	AC-FR
Speed	:	3 Speeds - 1/2/3

wall regulator

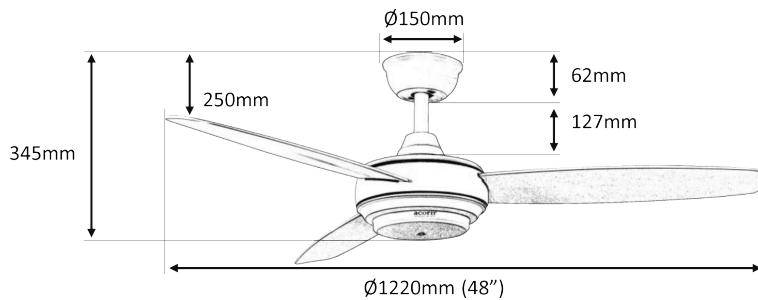

Model	:	AC-F623
Timer	:	1/3/6hrs
Light	:	On/Off
Speed	:	Low/Med/High

remote control



**ACORN**<sup>®</sup>  
ceiling fan specialist

**ACORN MARKETING & SERVICES PTE LTD**